

A background image showing various fire equipment: a red fire hose nozzle with a black handle and a red band with '30' and '60' markings; a yellow fire hose with 'SUPPLY' printed on it; and a fire hydrant cap with a mesh screen.

# AMERICA'S PREMIER FIRE EQUIPMENT MANUFACTURER

Tel: 800-420-4673  
Fax: 800-772-0255  
KOCHEK.COM

2017  
**Catalog**

# TABLE OF CONTENTS

<b>HOSES</b>	<b>4</b>	<b>VALVES</b>	<b>31</b>
PVC Suction Hose	4	Butterfly Valve	31
Elite Pro DJ EPDM	5	Gate Valves	32
Elite Pro DJP	6	Ball Valve	33
RC Rubber Covered	7	Piston Intake Valve	34
SJP Thermoplastic Lined Single Jacket Forestry	8	Siamese Valve	35
Rubber Covered LDH	9		
Kochek DJ Series Hose	10	<b>CAPS &amp; PLUGS</b>	<b>36</b>
Kochek DJP Series	11	<b>ST2</b>	<b>37</b>
Booster Hose	12	ST2 Dry Lubricant	37
<b>HOSE ACCESSORIES</b>	<b>13</b>	<b>ADAPTERS</b>	<b>38</b>
Hose Washers	13	Threaded & Storz	38
Hose Rollers	13		
		<b>COLOR CHART</b>	<b>39</b>
<b>NOZZLES</b>	<b>14</b>	<b>ELBOWS</b>	<b>40</b>
Break-A-Way Nozzles	14	Storz Elbows	40
		Suction Elbows	40
<b>HANDLINE NOZZLES</b>	<b>15</b>	Threaded Elbows	40
Defender Automatic	15	High Pressure Elbows	40
Defender Select	16		
Defender Constant	17	<b>MANIFOLDS</b>	<b>41</b>
Patriot Series	18	Back Outlet Body	41
		Angled Body	42
<b>STREET FIGHTER MANIFOLDS</b>	<b>19</b>	Square & Rectangle Body	43
<b>STRAINERS</b>	<b>20</b>		
Self Leveling Floating Strainer	20	<b>STORZ BUILDING CONNECTIONS</b>	<b>44</b>
Bottom Guard Barrel Strainer	21	<b>EXTERNAL STANDPIPE SLEEVES</b>	<b>45</b>
Basement Strainer	22	<b>FLANGES</b>	<b>46</b>
Low Level Strainer	22	Flange Styles & Options	46
Barrel Strainer	23	Carbon Steel ANSI Flanges	47
Box Strainer	24		
Ice Strainer	25	<b>ACCESSORIES</b>	<b>48</b>
		Spanners & Wrenches	48
<b>WATER TRANSFER</b>	<b>26</b>	SWC Wheel Chocks	49
Holley Transfer Pipe	26	Line Gauges	50
		Mounting Plates	50
<b>DRY HYDRANTS</b>	<b>27</b>	Gaskets	50
<b>HYDRANT CONVERTERS</b>	<b>28</b>		
SZMC Low Profile, Hydrant Nut Cap	28	<b>FORESTRY PRODUCTS</b>	<b>51</b>
SZMC Storz Standard Style	29		

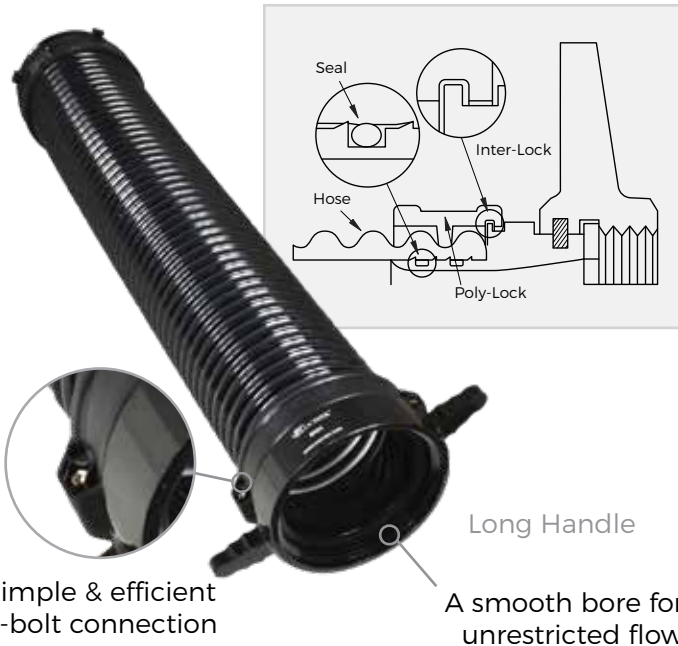

Simple & efficient 2-bolt connection

Long Handle  
A smooth bore for unrestricted flow

ID (inches)	OD (inches)	Min Bend Radius (inches)	Lbs./ Ft. UNCPLD (inches)
3	3.64	6	1.1
4	4.76	8	1.9
5	5.75	12	2.4
6	7.00	14	3.7
8	9.18	24	5.99

2P45 Uses 5" Hose: P25 Uses 3" Hose

### How Does Yours Measure Up?

PVC	Kochek Grade	Construction Grade
Helix Pitch	$\frac{11}{16}$ (0.688)	$\frac{7}{8}$ (0.875)
Space Between	$\frac{9}{32}$ (0.281)	$\frac{15}{32}$ (0.469)
Cross Sectional Wall Thickness	$\frac{27}{64}$ (0.421)	$\frac{5}{16}$ (0.3125)

Kochek Fire Grade

Construction Grade



0.688 0.281



0.875 0.469

Kochek's specialty enhanced ribbing eliminates collapsing.

## PVC SUCTION HOSE

### Your Single Source of Water Supply

Our PVC suction hose is specifically designed for the firefighting market and to Kochek's proprietary specifications.

#### KEY FEATURES:

- Meets all requirements of NFPA 1961
- Retains a quality wall thickness from 3" to 6" ID
- Flexibility from 150 F° to -40 F°
- UV protection designed into the hose
- 2 1/2" and 3" use bowl couplings

#### PVC Suction Options & Finishes



NH R L F x NH RL Male Hardcoat



Storz Rigid Long Handle Hard Coat



Storz without Handle



Aluminum Cam-Lock Couplings



NH Folding Long Handle F x R L Male



Storz Folding Long Handle

#### 24K - 6" SUCTION SIAMESE:

- Easy and fast setup
- Eliminates the need to draft from both sides of the truck
- Able to maximize flow to truck and pump design as much as 2000 GPM with 24K
- Must have 2,000 GPM pump



ELITE PRO SERIES

# DJ EPDM RUBBER LINED DOUBLE JACKET

This heavy duty double jacket rubber lined attack hose is NFPA compliant. Made in the U.S.A.



DJEP175151-5

**KEY FEATURES:**

- 100% synthetic all polyester double jacket
- 100% mildew resistant
- Heavy wall EPDM rubber liner
- 10 year warranty
- 25% lighter

**4 SIZES AVAILABLE:**



Part ID	Size (inches)	Service Test	Proof Test	Burst Test	Bowl Size (inches)	Weight/ft. Uncoupled
DJEP15151-	1 1/2	400 PSI	800 PSI	1200 PSI	1 15/16	0.34 lbs
DJEP175151-	1 3/4	400 PSI	800 PSI	1200 PSI	2 1/8	0.38 lbs
DJEP25251-	2 1/2	400 PSI	800 PSI	1200 PSI	3	0.54 lbs
DJEP30251-	3	400 PSI	800 PSI	1200 PSI	3 1/2	0.74 lbs

Available in 50' and 100' lengths. Part numbers list above pertain to 50' hoses. When ordering colors add the # to the part number that correlates with the desired color. Example: 1.75" X 50' in green: DJK175151-5

NFPA Colors & Special Stripe		
White -2	Red -3	Yellow -1
Green -5	Orange -6	Blue -4
Tan -8	Black -7	

<p><b>MORE LDH HOSES</b></p> <p>DJP Thermoplastic Lined Double Jacket Synthetic See page 6</p>		<p>RC Rubber Covered Attack Hose See page 7</p>		<p>SJP Thermoplastic Lined Single Jacket Forestry See page 8</p>		<p>Rubber Covered LDH See page 9</p>	
--	--	---	--	--	--	--	--



DJPEP175151-6

ELITE PRO SERIES

# DJP THERMOPLASTIC LINED DOUBLE JACKET SYNTHETIC

This lightweight compact all poly double jacket hose with TPU liner is ideal for high rise packs. It packs tighter allowing for reduced hose bed space. The smooth waterway reduces friction loss and improves flexibility. Made in USA.

**KEY FEATURES:**

- 100% synthetic all polyester double jacket
- 100% mildew resistant
- Polyurethane liner
- NFPA compliant
- 10 year warranty against manufacturing defects

NFPA Colors & Special Stripe

White -2	Red -3	Yellow -1	Tan -8
Green -5	Orange -6	Blue -4	Black -7

**7 SIZES AVAILABLE:**

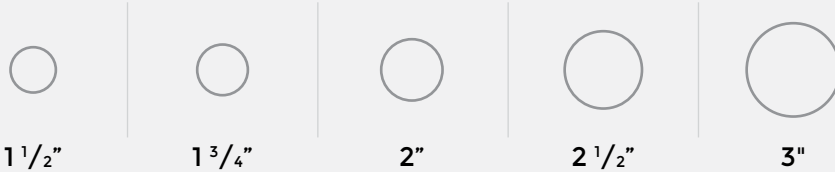

Part ID	Size (inches)	Service Test	Proof Test	Burst Test	Bowl Size (inches)	Weight/ft. Uncoupled
DJPEP15151-	1 1/2	400 PSI	800 PSI	1200 PSI	1 15/16	0.28 lbs
DJPEP175151-	1 3/4	400 PSI	800 PSI	1200 PSI	2 1/8	0.30 lbs
DJPEP20151-	2	400 PSI	800 PSI	1200 PSI	2 1/2	0.31 lbs
DJPEP25251-	2 1/2	400 PSI	800 PSI	1200 PSI	3	0.46 lbs
DJPEP30251-	3	400 PSI	800 PSI	1200 PSI	3 17/32	0.62 lbs

# RC RUBBER COVERED ATTACK HOSE

**KEY FEATURES:**

- Nitrile/PVC through-the-weave rubber covered construction
- NFPA compliant attack hose
- Lightweight
- Heat resistant
- Chemical resistant
- Maintenance free
- Raised thick rib construction to aid abrasion resistance



RC15151-3

**5 SIZES AVAILABLE:**



NFPA Colors	
Red -3	Blue -4
Green -5	Orange -6

Part ID	Size (Inches)	Service Test	Proof Test	Burst Test	Bowl Size (inches)	Weight/ft. Uncoupled
RC10101-	1	300 PSI	600 PSI	900 PSI	1 <sup>3</sup> / <sub>16</sub>	0.20 lbs
RC15151-	1 1/2	300 PSI	600 PSI	900 PSI	1 <sup>13</sup> / <sub>16</sub>	0.24 lbs
RC175151-	1 3/4	300 PSI	600 PSI	900 PSI	1 <sup>15</sup> / <sub>16</sub>	0.28 lbs
RC20151-	2	300 PSI	600 PSI	900 PSI	2 <sup>1</sup> / <sub>4</sub>	0.32 lbs
RC25251-	2 1/2	300 PSI	600 PSI	900 PSI	2 <sup>13</sup> / <sub>16</sub>	0.48 lbs

<p><b>MORE LDH HOSES</b></p>	<p>DJ EPDM Rubber Lined Double Jacket See page 5</p>	<p>DJP Thermoplastic Lined Double Jacket Synthetic See page 6</p>	<p>SJP Thermoplastic Lined Single Jacket Forestry See page 8</p>	<p>Rubber Covered LDH See page 9</p>
------------------------------	--	---	--	--



SJPK15151-2

## SJP THERMOPLASTIC LINED SINGLE JACKET FORESTRY

### KEY FEATURES:

- USDA first article tested and approved
- 5100-187c compliant
- Ring spun polyester to aid abrasion resistance
- Designed for rigorous forestry applications
- Super lightweight construction
- Threaded couplings

### 2 SIZES AVAILABLE:



1"

1 1/2"

### 5100-187 COLORS:

Clear -1	Yellow -2

Part ID	Size (inches)	Service Test	Proof Test	Burst Test	Bowl Size (inches)	Weight/ft. Uncoupled
SJPK10101-	1	300 PSI	600 PSI	800 PSI	1 3/16	0.07 lbs
SJPK15151-	1 1/2	300 PSI	600 PSI	800 PSI	1 3/4	0.13 lbs

**MORE LDH HOSES**

**DJ EPDM Rubber Lined Double Jacket**  
See page 5



**DJP ThermoPlastic Lined Double Jacket Synthetic**  
See page 6



**RC Rubber Covered Attack Hose**  
See page 7



**Rubber Covered LDH**  
See page 9



# RUBBER COVERED LDH HOSE

The large diameter rubber covered supply hose has a thin rib construction to aid abrasion resistance. This supply hose is NFPA compliant.



RC5078

**KEY FEATURES:**



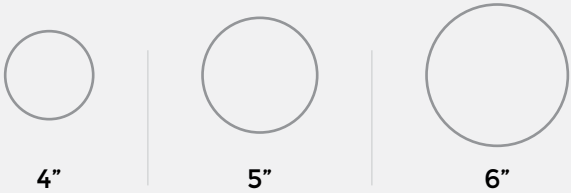

- Chemical resistant
- Lightweight
- Heat resistant
- Maintenance free
- Nitrile/PVC through-the-weave rubber covered construction
- Hose is coupled with reattachable forged storz head couplings with stainless steel lock
- Yellow and Red are standard
- Inquire about other colors

**3 SIZES AVAILABLE:**



Part ID	Size (inches)	Service Test	Proof Test	Burst Test	Weight/ft. Uncoupled
RC4078	4	250 PSI	500 PSI	750 PSI	0.24 lbs
RC5078	5	225 PSI	450 PSI	675 PSI	0.28 lbs
RC6078	6	225 PSI	450 PSI	675 PSI	0.32 lbs

**MORE LDH HOSES**

- DJ EPDM Rubber Lined Double Jacket See page 5 
- DJP Thermoplastic Lined Double Jacket Synthetic See page 6 
- RC Rubber Covered See page 7 
- SJP Thermoplastic Lined Single Jacket Forestry See page 8 





DJ15151-2

## KOCHEK DJ SERIES HOSE

Heavy duty polyester double jacket hose with a EPDM rubber liner. This hose is NFPA compliant and Made in China.

### KEY FEATURES:

- 100% virgin polyester
- High abrasion resistance
- Mildew resistant
- 10 year warranty

### 4 SIZES AVAILABLE:

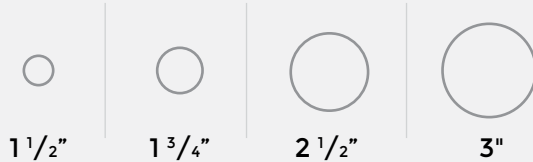

Part ID	Size (inches)	Service Test	Proof Test	Burst Test
DJ15151-	1 1/2	400 PSI	800 PSI	1200 PSI
DJ175151-	1 3/4	400 PSI	800 PSI	1200 PSI
DJ25251-	2 1/2	400 PSI	800 PSI	1200 PSI
DJ30251-	3	400 PSI	800 PSI	1200 PSI

### Color Options

White -2	Red -3	Yellow -1	Tan -8
Green -5	Orange -6	Blue -4	

# KOCHEK DJP SERIES HOSE

Lightweight all polyester double jacket with a TPU liner. Compact and flexible minimizes bed space and ideal for high rise packs. Made in China and meets or exceeds NFPA 1961.

### KEY FEATURES:

- 100% virgin polyester jacket
- High abrasion resistance
- Compact and flexible
- Mildew resistant
- 10 year warranty



DJP25251-1

Part ID	Size (inches)	Service Test	Proof Test	Burst Test
DJP15151-	1 1/2	400 PSI	800 PSI	1200 PSI
DJP175151-	1 3/4	400 PSI	800 PSI	1200 PSI
DJP25251-	2 1/2	400 PSI	800 PSI	1200 PSI
DJP30251-	3	400 PSI	800 PSI	1200 PSI

### 4 SIZES AVAILABLE:



### Color Options

White -2	Red -3	Yellow -1	Tan -8
Green -5	Orange -6	Blue -4	



Color Options: Green or Red  
Above shown with expansion couplings

## KBH LIGHTWEIGHT BOOSTER HOSE

Kochek's KBH Lightweight Booster Hose is highly resistant to ozone and abrasion. It offers outstanding low temperature performance, excellent mechanical properties, as well as good resistance to oil and grease.

Hose Specifications					
Hose Diameter	Bowl Size	Service Pressure	Proof Pressure	Burst Pressure	Weight 100'
1"	1 11/32"	300 PSI	600 PSI	1800 PSI	20 lbs.

### APPLICATIONS:

- Booster Reel Hose
- Industrial Hose
- Wildland/Forestry Fires
- Grass and Brush Fires

### KEY FEATURES:

- Lightweight, kink resistant and non-collapsible.
- Equipped with Full Flow expansion ring and 1" Lightweight Aluminum Rocker Lug coupling.
- Single jacket, 100% high tensile strength virgin polyester yarns; smooth TPU lining ensures the minimum friction for maximum flow.

### RTC COUPLINGS:

- A reusable 1" Reverse Pin Lug, Lightweight Aluminum Coupling.
- Powder Coated for durability.
- Designed to be used with Kochek's Booster hose.
- Storz reattachable couplings.



# HOSE WASHERS

The hose washer permits washing of the fire hose without brushing the hose. Two cone shaped pressure jets wash the hose twice during each application. The impact of the pressure jets from two annular gaps pulls the hose through the washer (some hand guidance may be needed).

The water flow gaps come with default factory settings. If more or less, is needed, use provided allen wrenches to adjust. The small allen screw increases/decreases water flow while the larger allen screws lock the position.



**KHW3**  
Up to 3" diameter hose  
Washer comes standard with 2 1/2" NH swivel  
(not shown in picture)

### OPERATION INSTRUCTIONS:

- Use on a flat, clean surface only.
- Connect a 2 1/2" hose the inlet of the hose washer. Slowly open the water supply to the connected hose line and begin flowing water to the appliance increase pressure slowly.
- Pass the hose through the washer orifice into the washer, the pressure of the water jets will aid in pulling the hose line through the washer.
- Slowly guide the hose through the washer to fully rinse dirt and debris from the hose, then repeat process if necessary.

### KEY FEATURES:

- Comes with a water inlet screen to prevent impurities from entering the washer.
- Can be used up to 3" diameter hose.
- Weight: 17 lbs.
- Washer operates best at 100 PSI
- Warranty: 5 years

# HOSE ROLLERS

We also carry two styles of Hose Rollers



**KHR-1**  
KHR Hose Drainer One Man



**KHR-2**  
KHR Hose Drainer Two Man

## STREET FIGHTER MANIFOLDS

The Street Fighter manifold is designed for fast and efficient means of delivering high flows of water to any scene. The lightweight unit is easily placed into position and used with our LDH HOSE creating a portable above ground firefighting system. Available in many combinations which will help departments deliver high volumes of water to the next fire, emergency or natural disaster.

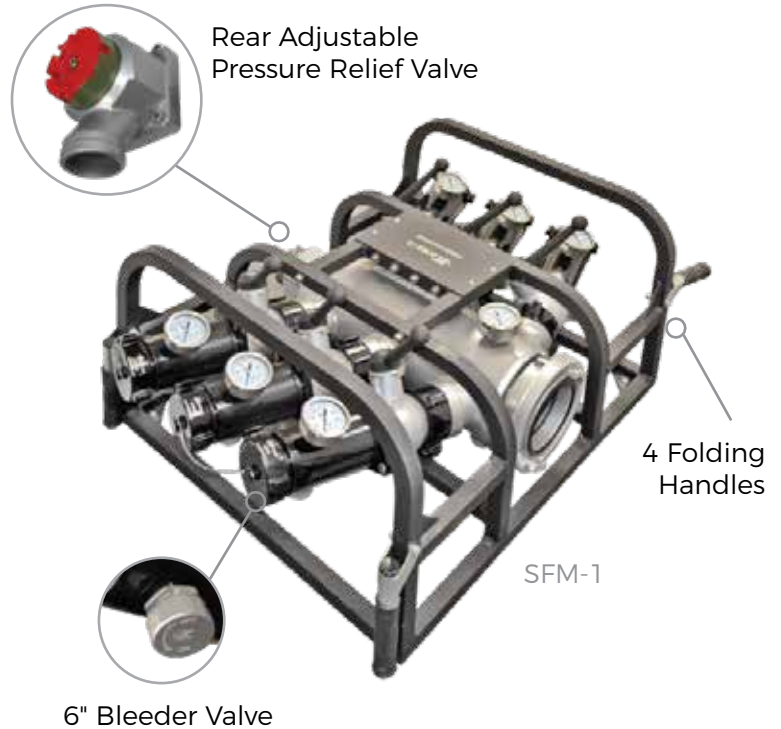

### Additional Models



**KSF-S507251**



**SP-KNEP-KSF5S6**



**SP-KNEP-KSF5S525**



**DMMS5S10**

### UNIT IS EQUIPPED WITH:

- 6 Total Discharge Valves 2 1/2" or 3"
- 6 Pressure Gauges
- 6 Drain Bleeder Valves
- 6 Caps with Cables
- Large Diameter Inlet
- Rear Adjustable Pressure Relief Valve
- 4 Folding Handles
- Lightweight and Durable Aluminum
- Welded Frame

Custom configurations available please inquire

U.S. Patent No. 7794589



FBS602

## SELF LEVELING FLOATING STRAINER

Most efficient strainer in today's market!

### KEY FEATURES:

- Handle for ease of carrying
- Vortex Shield protects against whirlpooling
- Full time swiveling strainer
- Made with 8" tubing
- Increased flow rates due to high intake ratio
- Maximum pump flows
- Lightweight design
- NEW compact design for easy storage
- Also available with storz and camlock connections

Part Number	Weight (lbs.)	Length (inches)	Height (inches)	Width (inches)
<b>Big Water Self-Leveling Floating Strainer</b>				
FBS602	17	13.5	14.5	15.25
<b>Recommended for pumps 1500 to 2,000 GPM</b>				
FBS60	15.85	13.5	14.5	15.2
<b>Recommended for pumps 1250 to 1500 GPM</b>				
FBS50	12.4	11.75	13	15
FBS45	12.1	11.75	13	14.5
FBS40	11.95	11.75	13	14
FBS30	9	11.35	11.5	10.25
FBS25	8.75	11.35	11.5	10.25
FBS15	2.9	8.5	8.25	5

### Self Leveling Series



# BOTTOM GUARD BARREL STRAINER

An innovative design incorporating a unique guard that makes drafting possible in many conditions. Our rugged, lightweight, compact strainer allows for protected maximum flow.



BS602BG



BSBG Series

## KEY FEATURES:

- The “Bottom Guard Strainer” was designed to work with gravity. As the strainer moves toward the water’s bottom, the guard swivels to the underside of the barrel strainer, providing a clean, stable platform from which to draft.
- The high intake ratio allows for pump capacity flow rates while the bottom guard protects against debris from being drawn to the bottom, so silt, rocky and weeded conditions are not an issue.
- The balanced handle along with being light-weight makes it easy to carry and quickly deploy.
- Compact in design, the “Bottom Guard Strainer” makes for easy convenient storage.
- Available with Threaded, Storz, or Camlock connections in a range of sizes.
- Aluminum construction with a wrinkle black powder coated finish on the guard.

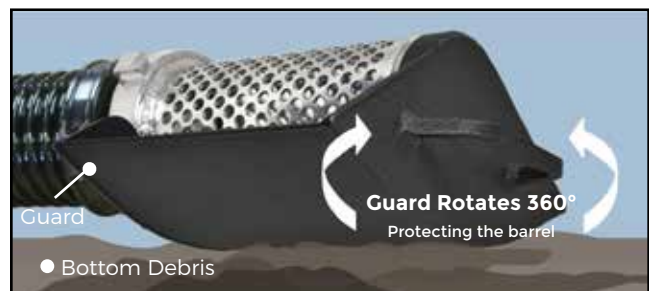

*Guard in position protecting the Barrel Strainer*



LL602 Big Water

## LOW LEVEL STRAINER

The low level strainer features full flow capacity with 8" tubing. Comes equipped with a standard external screen and a base pan designed with side walls to protect the tank.

### KEY FEATURES:

- Made with 8" tubing
- Lightweight aluminum alloy
- Water Transfer Device
- Drafts down to 2" from bottom
- Pivoting, adjustable elbow
- Base pan design has additional side walls eliminating tank damage
- 2 1/2" to 6", internal screen is standard
- 6" Big Water; external screen is standard
- Meets NFPA Standard

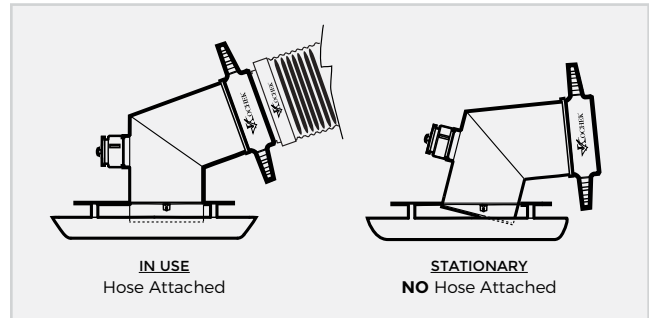

Barrels change according to the size/flow.  
Also available with Foot Valve.

Part Number	Weight (lbs.)	Length (inches)	Height (inches)	Width (inches)
<b>Big Water Low-Level Strainer</b>				
LL602	18.75	15.75	15	15.75
<b>Recommended for pumps 1500 to 2,000 GPM</b>				

LL60	15	18	13.37	15.75
<b>Recommended for pumps 1250 to 1500 GPM</b>				

LL50	15	17.4	12.7	15.75
LL45	13	17.4	12.7	15.75
LL40	12	17.4	12.4	15.75
LL30	10	17.25	10.5	15.75
LL25	10	17.25	10.1	15.75

LL25, LL30 and LL602 come standard without siphon.  
Jet Siphon available on LL602 please inquire.

## BASEMENT STRAINER

We carry three styles of **Basement Strainers**, Storz, NH & Camlock



BL-  
Storz Style Basement Strainer

OPTIONAL  
EXPANSION



Jet Siphon  
Call for details



# BARREL STRAINER



"U" for easy Laynard Connection



BS60

**AVAILABLE IN:**

NH Connection



Camlock Connection



Storz Connection



**KEY FEATURES:**

- Made with 8" Tubing
- High Performance Design
- Pump Capacity
- Lightweight
- Offered in a variety of finishes

**Available Finishes**



K-Coat



Hardcoat



K-Chrome



Silverdillo Powder Coat

**MORE STRAINERS**

Self Leveling Floating Strainer  
See page 20



Ice Strainer  
See page 25



Low Level Strainer  
See page 22



Box Strainer  
See page 24





"U" for easy Laynard Connection



Camlock Connection



NH Connection

## BOX STRAINER

An innovative design incorporating a unique guard that makes drafting possible in many conditions. Our rugged, lightweight, compact strainer allows for protected maximum flow.



Bottom Debris

*Lays flat to prevent silt and debris from entering the strainer's flow*

### KEY FEATURES:

- High Performance Design
- Pump Capacity
- Lightweight
- Available in NH, Camlock and Storz connections (Storz: 2 1/2", 3", 4", 5", 6")
- Standard finish is Silvadillo Powder Coat with Black Powder Coated Grill
- Other Finishes offered: K-Coat Color (Colored Powder Coat)

#### MORE STRAINERS

Self Leveling Floating Strainer  
See page 20



Barrel Strainer  
See page 23



Low Level Strainer  
See page 22



Ice Strainer  
See page 25



# ICE STRAINER

Long-handled attachment that simplifies water drafting from frozen ponds.

Our ice strainers are essential for firefighters who depend upon rural water in colder climates. Kochek's Ice Strainer meets the industry's need for a compact, efficient straining device that stays level while producing maximum water flow. Saves time by requiring a smaller hole in the ice, unlike traditional size strainers. Effectively blocks debris from entering the hose or pump, and the product's design also ensures that the strainer remains below ice level. Kochek's strainers are constructed of lightweight aluminum yet are durable to withstand harsh winter conditions while delivering maximum water flow capacity.

Camlock Option



Storz Option



IS604

### KEY FEATURES:

- Available in sizes from four to six inches.
- NH, Storz, and Camlock styles.
- Features a variable depth gauge.
- Attaches easily to the end of a suction hose then turns 90 degrees to allow the strainer to drop through a hole in the ice.

### 2 SIZES AVAILABLE:



4"



5"



6"

#### MORE STRAINERS

Self Leveling Floating Strainer  
See page 20



Barrel Strainer  
See page 23



Low Level Strainer  
See page 22



Box Strainer  
See page 24



U.S. Patent No. 7644776

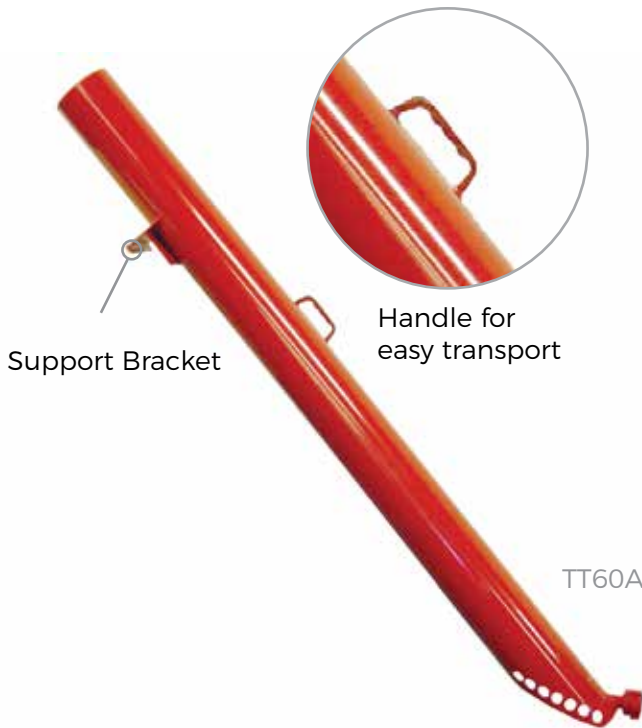

## HOLLEY TRANSFER PIPE

**Saving lives by moving water fast!**

The Holley Transfer Pipe moves water more efficiently from a dump tank to a drafting tank when fighting fires. This process, commonly utilized in rural firefighting, is vital for saving firefighters time. The transfer pipe is an “all-in-one” unit that requires no assembly. The Holley Transfer Pipe replaces existing lower volume methods of transferring water.

Intake Holes

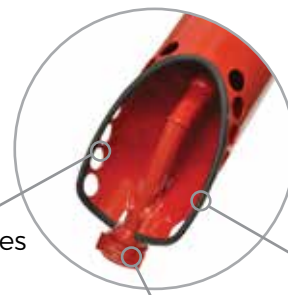

Jet Siphon

Rubber trim  
for added tank  
protection

Part Number	Length (inches)	Weight (lbs.)	Diameters (inches)	GPM (Depends on PSI)
TT60A	78	19	6	800-1400
TT80A	78	26	8	1400-1700

**Material:** 6061-T6, Lightweight Aluminum, Powder Coated

6in model comes with 1 1/2" NH Female Threaded Siphon

8in model comes with 2 1/2" NH Female Threaded Siphon

## DRY HYDRANT PRODUCTS



Visit our website to see ALL of our Dry Hydrant Products  
Also download a **FREE** copy of our Rural Water Design booklet.

Dry Hydrant Series		
		
<b>Reflective Sign</b> SDH	<b>Femal Adapter</b> DHF612	<b>Shallow Strainer</b> TDS6
		
<b>Polymer Cap</b> DHPC50	<b>HS PVC Strainer</b> HS611	



*Dry Hydrant in use next to reflective sign*

### MATERIALS:

- Light-weight 6061-T6 Aluminum Alloy on connectors.
- Schedule 40 Standard PVC piping

### CONFIGURATION:

- 90 and 45 Degree PVC elbows
- Threaded, Storz and Camlock
- Complete Line of PVC Strainers
- Full-Time Swivel available on the riser
- All Dry Hydrants include screen

## HYDRANT CONVERTERS

### SZMC Low Profile, Hydrant Nut Cap



SZMC5045-3-Y

SZMC5045-3

#### KEY FEATURES:

- Aluminum Alloy 6061-T6 extruded forging only.
- (3) Stainless steel set screws for mounting.
- The NH thread female adapter contains a flat rubber gasket which seals against the male hydrant nozzle.
- The head has a 1/2" relief machine cut around the outside creating a recess for the insertion of highly visible, reflective yellow tape.

#### CAP CONSTRUCTION:

**ASSEMBLY** Both the center cap and the outer assembly containing the Storz ramps and lugs is Aluminum alloy 6061-T6 forged extrusion only. Cap is equipped with cable. Once installed, the Storz Hydrant Converter with cap extends less than 3" from the hydrant nozzle.

**CABLE** 3/32", (7 x 7) Stainless steel aircraft cable w/ stainless steel eyelet end is supplied with the cap.

**GASKETS** Commercial grade neoprene & molded SBR rubber

**SCREWS** 304 stainless steel socket head screws

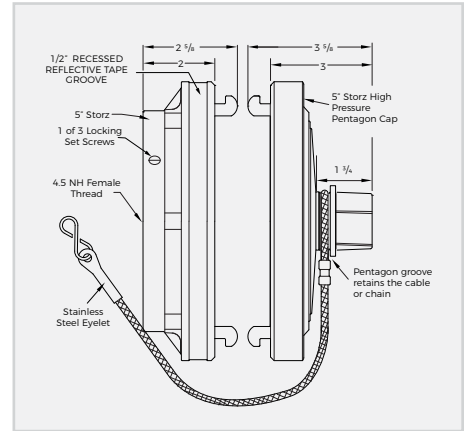

#### Hardcoat



#### Micralox® Hardcoat Anodized

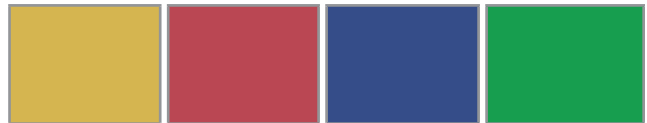

#### Hardcoat Anodized



#### Powder Coat



## HYDRANT CONVERTERS

### SZMC Storz Standard Style

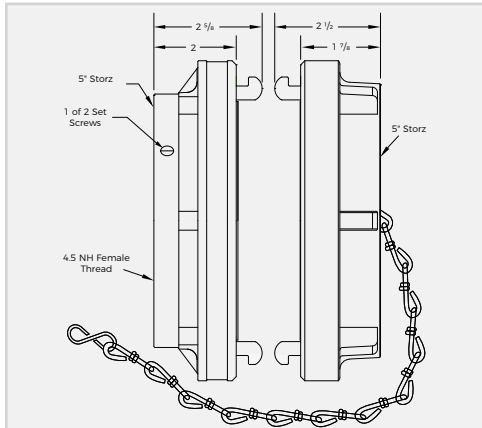

SZMC5045-2

#### Hardcoat Combination



#### Cover Color Options



Also available in Micralox, Hardcoat and Powder Coat options.

#### KEY FEATURES:

- Aluminum Alloy 6061-T6 extruded forging only.
- (2) Stainless steel set screws for mounting.
- Set screws must be mounted 180 degrees apart.
- The converter is hard anodized aluminum metal face seal and hard anodized aluminum Storz ramp and lugs.
- The NH thread female adapter contains a flat rubber gasket which seals against the male hydrant nozzle.
- The high torque, anti theft cap requires a Storz wrench for removal.

#### CAP CONSTRUCTION:

**ASSEMBLY** Both the center cap and the outer assembly containing the Storz ramps and lugs is Aluminum alloy 6061-T6 forged extrusion only. Cap is equipped with a chain. Once installed, the Storz Hydrant Converter with cap extends less than 3" from the hydrant nozzle.

**CABLE** 3/32", (7 x 7) Stainless steel aircraft cable w/ stainless steel eyelet end is supplied with the cap.

**GASKETS** Commercial grade neoprene & molded SBR rubber

**SCREWS** 304 stainless steel socket head screws



## HYDRANT CONVERTERS

### SZMC Low Profile, Hydrant Nut Cap

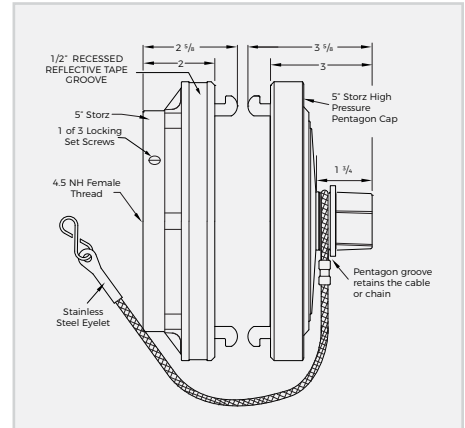

#### KEY FEATURES:

- Aluminum Alloy 6061-T6 extruded forging only.
- (3) Stainless steel set screws for mounting.
- The NH thread female adapter contains a flat rubber gasket which seals against the male hydrant nozzle.
- The head has a 1/2" relief machine cut around the outside creating a recess for the insertion of highly visible, reflective yellow tape.

#### CAP CONSTRUCTION:

**ASSEMBLY** Both the center cap and the outer assembly containing the Storz ramps and lugs is Aluminum alloy 6061-T6 forged extrusion only. Cap is equipped with cable. Once installed, the Storz Hydrant Converter with cap extends less than 3" from the hydrant nozzle.

**CABLE** 3/32", (7 x 7) Stainless steel aircraft cable w/ stainless steel eyelet end is supplied with the cap.

**GASKETS** Commercial grade neoprene & molded SBR rubber

**SCREWS** 304 stainless steel socket head screws

#### Hardcoat



#### Micralox® Hardcoat Anodized



#### Hardcoat Anodized



#### Powder Coat





# BUTTERFLY VALVE



**KEY FEATURES:**

- The Inner Disc closes off the flow.
- Rotating the handle to open the disc a quarter turn allows an almost unrestricted water flow.
- The 10 position Lever Handle, with positive detents allows the valve to be opened or closed incrementally for a controlled water flow.
- Comes standard with Bleeder Valve.
- Available with Threaded, Storz, Camlock connections, Hand Wheel and other sizes.
- Weight: 45 lbs.



*Butterfly Valve with 10 position lever handle*





09K25225M



09KT25225M

Gate Valve 2.5 NH SW RL F x 2.5 NH M

## 09K GATE VALVE

Excellent shut off valve used on 2 1/2" Hydrant outlets to control water hammer and reduce hydrant main damage. Offering two styles of handles, traditional hand and crank, this valve has a lightweight, durable aluminum body construction which is powder coated for corrosion resistance.

### Available LDH Gate Valves



### KEY FEATURES:

- Non rising stem with crank
- Metal to metal seat
- Ideal for use in hose testing and on hydrants, stand pipes and pumps.

Maximum Operating Pressure	Weight (lbs.)	Length (inches)
300 PSI	4.2	13 x 5.25 x 5.25

Less than nine turns to open and close.

# 26K 2-WAY BALL VALVE

The Kochek **2-Way Ball Valve** is used for splitting a single water supply when two are desired on a fire scene. Valve can be installed between hose lays, on fire hydrants, trucks or standpipes.

Part Number	Working Pressure	Weight (lbs.)	Length (inches)	Width (inches)	Height (inches)
26K1525	200 PSI	4.1	5.5	9.125	4.5

**Material:** Cast Aluminum **Color:** Red & Black



26K 2-Way Ball Valve in use.



## 70K PISTON INTAKE VALVE

A compact, lightweight, powder coated aluminum body piston valve with a 45 degree valve. Corrosion resistant brass piston and designed for maximum flows.

Weight (lbs.)	Height (inches)	Width (inches)	Extends (inches)
25	16 <sup>3</sup> / <sub>4</sub>	7 <sup>3</sup> / <sub>4</sub>	10 <sup>1</sup> / <sub>4</sub>
<b>Friction Loss:</b> 6 PSI at 1,500 GPM; 10 PSI at 2,000 GPM			

### KEY FEATURES:

- Highly corrosion resistant chrome-plated brass internal piston.
- Large turbulence reducing oval waterway for minimal friction loss.
- Forged storz head with stainless steel locking mechanism.
- Pressure relief valve allows for easy adjustments from 75-250 PSI in increments of 25 with round 2 5/8" dump.
- Extends only 10 1/4" from pump panel.
- Available with full time swiveling storz heads to prevent hose kinking.

Tested per NFPA 1965

OTHER LDH APPLIANCES



**32K**  
Manifold & Hydrassist Valve



**51K**  
Manifold & Hydrassist Valve



**80K**  
Manifold & Hydrassist Valve

# SIAMESE VALVE

All four styles of Kochek's Siamese Valve feature an aluminum body and clapper valve. Several different configurations and valve discharge use may affect actual friction loss created in the field. The fire department should evaluate actual friction loss during training.



20K0525

20K - 2 Way-Siamese-Clappered



30K 3-Way Siamese - Clappered

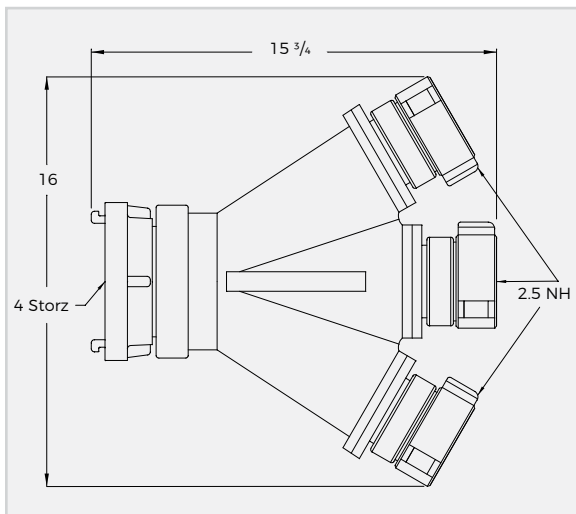
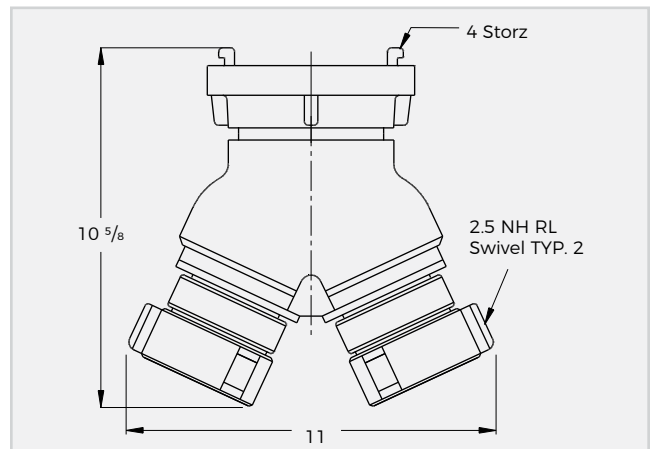

50K - Jumbo Siamese-Clappered











24K - 6" Suction Siamese



Examples of: Kochek Caps & Plugs

## CAPS & PLUGS

Caps			Plugs
			
CC Storz Cap with Chain	CC Hydrant Storz Cap with Cable	CC 201 Deep Throat Storz Cap with Chain	PL or PC Plug
			
CC Cap Gauge	CC Camlock Cap with Chain	CC or CP British Instantaneous Cap	PC Camlock Plug with Chain
			
			PL or PC British Instantaneous Plug

# ST2 DRY LUBRICANT

ST2 is a dry lubricant that will ease the connection of both Storz and Threaded parts. It is environmentally friendly containing NO grease. The lubricant applies wet, yet maintains it's smoothness when dry, preventing the attraction of dirt and debris. ST2 comes in a 2 oz. plastic spray bottle, sold as a case of 12 individual bottles.



12 oz. Trigger Spray  
Spray or Stream

ST2-12OZ



ST2

Counter Top Display Box



**Examples of:** Micralox and Hardcoat Color  
Other Colors Available

## KOCHEK ADAPTERS

Kochek offers a variety of adapters. They are available in a variety of configurations such as rocker lug, long handle, rigid, swivel, storz and special thread. They come in a many sizes and different finishes. The adapter lines meet or exceed all NFPA Standards.

### FINISHES:

**K-COAT** Tough, durable powder coating that is non conductive to help inhibit electrolysis, color consistent to delta 0.5, and available in many vivid colors.

**NATURAL HARDCOAT** 3/32", (7 x 7) Stainless steel aircraft cable w/ stainless steel eyelet end is supplied with the cap.

**GASKETS** High quality, durable finish that is most often specified by manufacturing engineers. Satin finish that meets Mil Spec 8625 Type III Class I.

**HARDCOAT** Vibrant anodized color, attractive, versatile, durable, even coverage, meets Mil Spec 8625 Type III Class II.

**MICRALOX®** A patented micro-crystalline anodizing process, offering long lasting colorized color hardcoat that offers superior resistance to abrasion and chemical corrosion. It extends the life of aluminum parts up to 10 times compared to conventional aluminum anodic coatings having withstood 15,000 hours of salt spray with no pitting. Ideal for harsh environments, coastal areas, marine applications or roadways where salt corrosion is a concern. Meets Mil Spec 8625 Type III Class II.

### Threaded Adapters

				
35R	57L	36R	37R	54R
				
53R	54L	56L	53L	

### Storz Adapters

				
S36S	S37S	S54R	S54L	S60S

All adaptors are available in all finishes.



# COLOR CHART

Our finishes are a great method to color code, whether it be K-Coat, Hardcoat or Micralox. Each finish type will now be indicated by a one-letter suffix/revision. For finishes where color options are available, these will be indicated by a two-digit color code.

Code	Finish	Example
- H	Natural Hardcoat	37R2515-H
- Y	Color K-Coat	37R2515-Y02
- Q	Hardcoat Color	37R2515-Q57
- M	Micralox	37R2515-M62
- C	K-Chrome	37R2515-C

## COLOR DESCRIPTIONS:

**K-COAT** Tough, durable powder coating that is non-conductive to help inhibit electrolysis, color consistent to delta 0.5, and available in many vivid colors.

**NATURAL HARDCOAT** High quality durable finish that is most often specified by manufacturing engineers. Satin finish meeting Mil Spec 8625 Type III Class I.

**HARDCOAT** Vibrant anodized color, attractive, versatile, durable, even coverage. Satin finish meeting Mil Spec 8625 Type III Class II.

**MICRALOX** A patented micro-crystal line anodizing process, offering long lasting colorized hardcoat with superior resistance to abrasion and chemical corrosion. It extends the life of aluminum parts up to 10 times compared to conventional aluminum anodic coatings, having withstood 15,000 hours of salt spray with no pitting. Ideal for harsh environments: Coastal Areas, Marine applications or roadways where salt corrosion is a concern. Meets Mil Spec 8625 Type III Class II.

**K-CHROME** Industries brightest high gloss chrome powder coating specially applied to have unparalleled chrome appearance and high reflectivity.

Hardcoat & Micralox Color Chart		
Color Name	Code	Color
Natural	51	
Black	52	
Blue	53	
Light Blue	54	
Clear	55	
Gold	56	
Green	57	
Light Green	58	
Grey	59	
Orange	60	
Purple	61	
Red	62	

K-Coat Color Chart					
Color Name	Code		Color Name	Code	
Robin's Egg	01		Yellow/Lime	10	
Dark Blue	02		Safety Yellow	11	
Lavender	03		Safety Orange	12	
Evergreen	04		Sky White	13	
Silver Fern	05		Almond	14	
Purple	06		Black Wrinkle	15	
Fire Engine Red	07		Lucy Brown	16	
Light Burgundy	08		Bronze	17	
Silvadillo	09		Black	18	

## THREADED ELBOWS

### Threaded Elbow Options



KE-R 30° Elbow SW RL Female to Male Threads SW RL F X M 30° Elbow



KE-L 30° Elbow SW LH Female to Male Threads SW RL F X M 30° Elbow



HPKE-R & RC 45° Elbow SW RL Female to Male Threads 45° High Pressure Elbow

## STORZ ELBOWS

### Storz Elbow Options



SKE-R 30° Elbow Swivel Rocker Lug Female to Storz



SKE-TR 30° Elbow Full time Swivel Storz to Rocker Lug Female



SKE-L 30° Elbow Swivel Long Handle Female to Storz



SKE-TL 30° Full time SW Storz to SW LH Female

## SUCTION ELBOWS



KEP-R SW RL Female to Male

## HIGH PRESSURE ELBOWS

### High Pressure Elbow Options



HPKE25R2590  
K-Coat



HPKE25R2590-Y  
Powder Coat

# BACK OUTLET BODY

Rugged, lightweight secondary inlet connections that supplement fire protection water supplies. Offered in different styles.

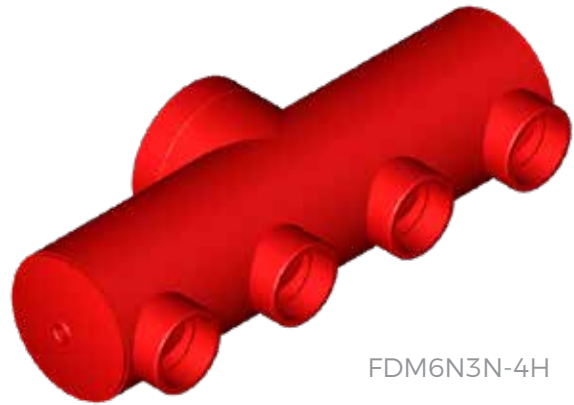

FDM6N3N-4H

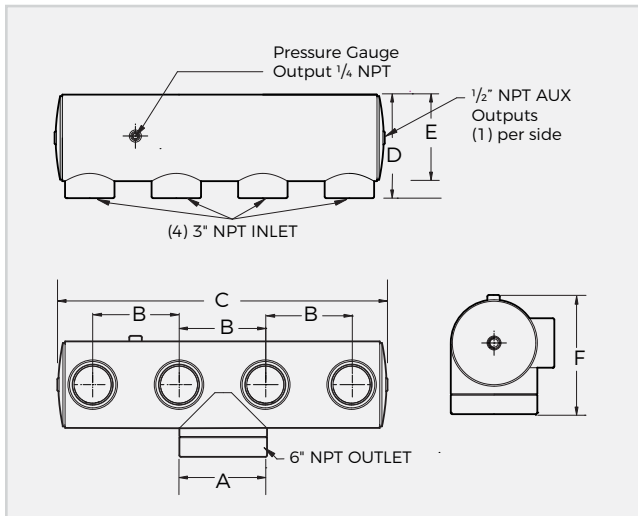

### SPECIFICATIONS:

**MATERIAL** Made from 6061-T6, Lightweight Aluminum.

**STANDARD FINISH** Powder Coated for longevity & durability.

**LASER ENGRAVING OPTIONS** Auto Spkr Standpipe, Dry Standpipe & Auto Spkr Standpipe.

**OPTIONAL FINISHES** K-Brass, K-Chrome, Hard Coat, Micalox.

**CONNECTION VARIATIONS** Threaded and Grooved.

**PRESSURE RATING** Working Pressure Rated at 300 PSI

Back Outlet Manifold Configurations

Vertical Part #	Horizontal Part #	Inlet No. & Size	Location	Size	Type	A	B	C	D	E
	FDM4N3N-2B	(2) 3" NPT	Back	4"	T	7	7	12 3/4	10 1/2	7
	FDM6N3N-3B	(3) 3" NPT	Back	6"	T	7	7	19 3/4	10 1/2	7
	FDM6G3N-3B	(3) 3" NPT	Back	6"	G	6 5/8	7	19 3/4	10 1/2	7
	FDM6N3N-4B	(4) 3" NPT	Back	6"	T	7	7	26 3/4	10 1/2	7
	FDM6G3N-4B	(4) 3" NPT	Back	6"	G	6 5/8	7	26 3/4	10 1/2	7
	FDM6N3N-6B	(6) 3" NPT	Back	6"	T	7	7	40 3/4	10 1/2	7
	FDM6G3N-6B	(6) 3" NPT	Back	6"	G	6 5/8	7	40 3/4	10 1/2	7
	FDM8N3N-6B	(6) 3" NPT	Back	8"	T	9 15/16	7	40 3/4	12 5/8	9 5/16
	FDM8G3N-6B	(6) 3" NPT	Back	8"	G	8 5/8	7	40 3/4	11	8 5/8

FDM8N3N-6V

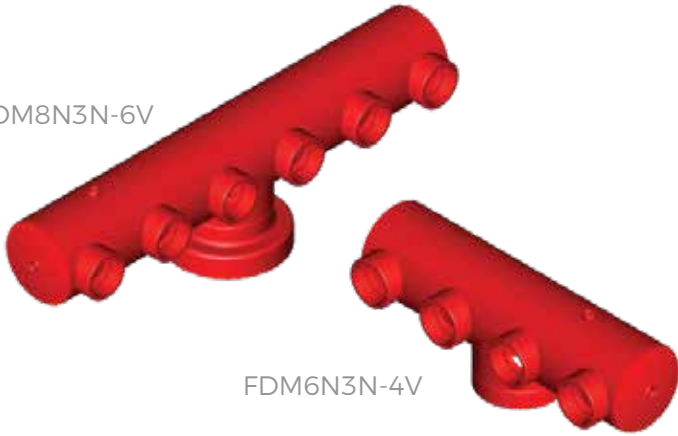

FDM6N3N-4V

## SPECIFICATIONS:

- MATERIAL** Made from 6061-T6, Lightweight Aluminum.
- STANDARD FINISH** Powder Coated for longevity & durability.
- LASER ENGRAVING OPTIONS** Auto Spkr Standpipe, Dry Standpipe & Auto Spkr Standpipe.
- OPTIONAL FINISHES** K-Brass, K-Chrome, Hard Coat, Micalox.
- CONNECTION VARIATIONS** Threaded and Grooved.
- PRESSURE RATING** Working Pressure Rated at 300 PSI

## ANGLED BODY MANIFOLD

Rugged, lightweight secondary inlet connections that supplement fire protection water supplies. Offered in different styles.

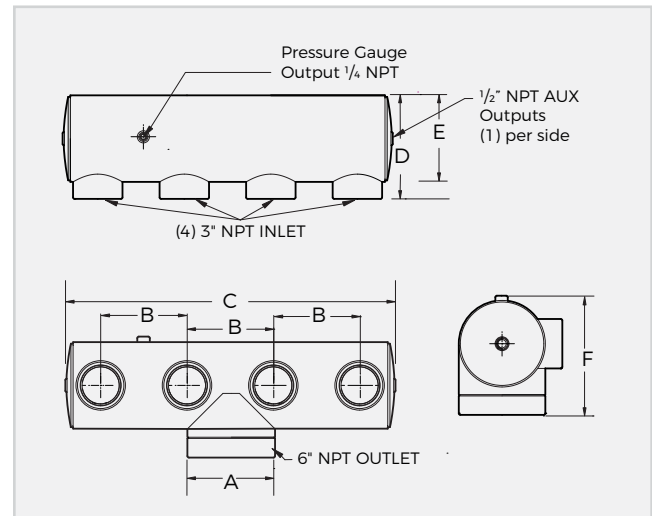

Back Outlet Manifold Configurations

Vertical Part #	Horizontal Part #	Inlet No. & Size	Location	Size	Type	A	B	C	D	E	F
FDM4N3N-2V		(2) 3" NPT	Vertical	4"	T	7	7	12 3/4	8 3/8	7	9 5/8
FDM6N3N-3V		(3) 3" NPT	Vertical	6"	T	7	7	19 3/4	8 3/8	7	9 5/8
FDM6G3N-3V		(3) 3" NPT	Vertical	6"	G	6 5/8	7	19 3/4	8 3/8	7	9 5/8
FDM6N3N-4V		(4) 3" NPT	Vertical	6"	T	7	7	26 3/4	8 3/8	7	9 5/8
FDM6G3N-4V		(4) 3" NPT	Vertical	6"	G	6 5/8	7	26 3/4	8 3/8	7	9 5/8
FDM6N3N-6V		(6) 3" NPT	Vertical	6"	T	7	7	40 3/4	8 3/8	7	9 5/8
FDM6G3N-6V		(6) 3" NPT	Vertical	6"	G	6 5/8	7	40 3/4	8 3/8	7	9 5/8
FDM8N3N-6V		(6) 3" NPT	Vertical	8"	T	9 15/16	7	40 3/4	9 7/8	7	11 3/4
FDM8G3N-6V		(6) 3" NPT	Vertical	8"	G	8 5/8	7	40 3/4	9 1/4	7	10 1/8

# SQUARE & RECTANGLE BODY

Rugged, lightweight secondary inlet connections that supplement fire protection water supplies. Offered in different styles.



### SPECIFICATIONS:

- MATERIAL** Made from 6061-T6, Lightweight Aluminum.
- STANDARD FINISH** Powder Coated for longevity & durability.
- LASER ENGRAVING OPTIONS** Auto Spkr Standpipe, Dry Standpipe & Auto Spkr Standpipe.
- OPTIONAL FINISHES** K-Brass, K-Chrome, Hard Coat, Micalox.
- CONNECTION VARIATIONS** Threaded and Grooved.
- PRESSURE RATING** Working Pressure Rated at 300 PSI

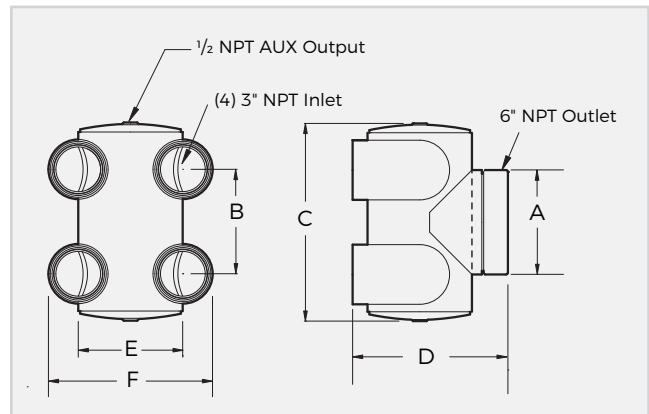

Back Outlet Manifold Configurations											
Vertical Part #	Horizontal Part #	Inlet No. & Size	Location	Size	Type	A	B	C	D	E	F
FDM6N3N-22V		(4) 3" NPT	Vertical	6"	T		7	14 3/8	8	7	11
	FDM6N3N-22H	(4) 3" NPT	Back	6"	T	7	7	13 1/4	10 5/8	7	11
FDM6G3N-22V		(4) 3" NPT	Vertical	6"	G		7	14 1/4	8	7	11
	FDM6G3N-22H	(4) 3" NPT	Back	6"	G	6 5/8	7	13 1/4	10 5/16	7	11
FDM8N3N-23V		(6) 3" NPT	Vertical	8"	T		7	23 1/2	9 1/2	9 15/16	11
	FDM8N3N-23H	(6) 3" NPT	Back	8"	T	9 15/16	7	20 1/4	12 3/8	7	11
FDM8G3N-23V		(6) 3" NPT	Vertical	8"	G		7	21 3/4	8 7/8	5 5/8	11
	FDM8G3N-23H	(6) 3" NPT	Back	8"	G	8 5/8	7	20 1/4	10 3/4	7	11

## Are Your Storz Building Connections UL Certified?



# STORZ BUILDING CONNECTIONS



Kochek Storz Building Connections are used as an auxiliary inlet to help supplement a fire protection system's water supply. Coupling reduces the typical connect time for emergency responders versus traditional threaded appliances. The lugged Storz head and cap make installation easy with standard wrenches in the market. The Nitrile gasket seals the Storz head and cap. This seal prevents moisture and foreign matter from entering the connection. Our Stainless Steel locking lever keeps the cap engaged and is a means for the installer to know when seal is complete.

Storz X NPT Rig F 30° Elbow W/ Cap | 4" & 5" 30 Degree Storz

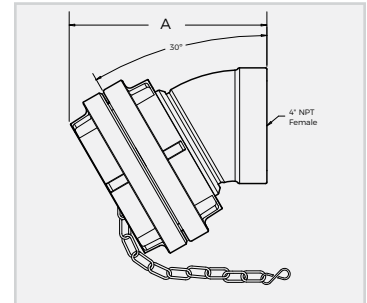
Product Image	Model	Pattern	"A" Dimension	Rated Pressure
	SFDCEB44N	30 Degree	7 7/8"	250 PSI
	SFDCEB54N	30 Degree	8 3/4"	250 PSI
	SFDCEB56N	30 Degree	10 5/8"	250 PSI



Storz X NPT Rig F W/ Cap | 4" & 5" Straight Storz FDC

Product Image	Model	Pattern	"A" Dimension	Rated Pressure
 	SFDC44N	Straightway	4 1/8"	250 PSI
	SFDC54N	Straightway	4 3/8"	250 PSI
	SFDC56N	Straightway	5 7/8"	250 PSI
	SFDC44N-UL	Straightway	4 nonthreaded by 4 npt	250 PSI
	SFDC54N-UL	Straightway	5 nonthreaded by 4 npt	250 PSI
	SZM4040-UL	Straightway	4 nonthreaded x 4 BSP	250 PSI
	SZM5050-UL	Straightway	5 nonthreaded x 5 BSP	250 PSI

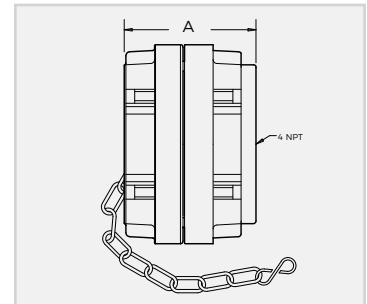

### MATERIAL:

- Forged Aluminum
- T6160, Nitrile Gasket

### FINISHES:

- **Standard:** Powder coat (17 standard colors)
- **Other Choices:** Hard coat, K-Chrome and K-Brass

## EXTERNAL STANDPIPE SLEEVES

Why settle for a traditional stand pipe whose finish will **discolor** or **oxidize** over time after being exposed to weather & other elements? Kochek stand pipe coating is made from extruded seamless aluminum that is not affected by UV light and their appearance will look **new** for many years.

Kochek offers UL approved Storz Connections



Standard 18" Pipes

Model Number	Sleeve Style/ Finish	Size (inches)
AS5X18-C-B	K-Brass	4
AS5X18-C	K-Chrome	4
AS5X18-Y	K-Coat (Powder Coat)	4
AS7X18-B-C	K-Brass	6
AS7X18-C	K-Chrome	6
AS7X18-Y	K-Coat (Powder Coat)	6

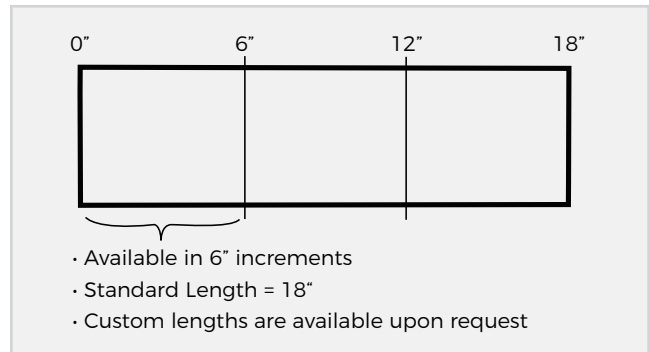

Finishes			
Silverdillo	Red	K-Chrome	K-Brass

# FLANGE STYLES & OPTIONS

Kochek flanges are made from carbon steel and can be used by in a variety of industries, including: firefighting, waste water & water management and industrial applications. They're a great way to designate proper hook up.



Flange X Camlock

Flange X Male



Flange X Storz



Flange X RL F SW



Flange X Groove

Our powder coat finish offers a broad selection in color

Robin's Egg	Dark Blue	Lavender	Evergreen	Silver Fern	Purple
Fire Engine Red	Light Burgandy	Silvadillo	Yellow/ Lime	Safety Yellow	Safety Orange
Sky White	Almond	Black Wrinkle	Lucy Brown	Bronze	Black

## LAZER ENGRAVING:



Custom laser engraving of company's names and logos



# CARBON STEEL ANSI FLANGES

For ordering Kochek's carbon steel ANSI flanges please note that for other powder coated colors add a "-Y" to the part number and indicate color. (For example: FGM66-Y Red) For ordering the option with 300lb. ANSI flange, add "-300" to the part number. (For example: FGM66-300)

Pressure Rated To:		
Service	Test	Burst
300	600	900



150lb. Flange X Storz



150lb. Flange X RL F SW



Flange X Storz  
FGS Part Numbers

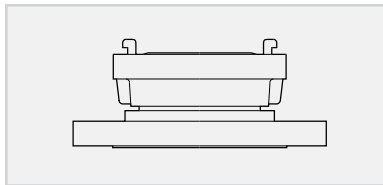

Flange X Male  
FGM Part Numbers

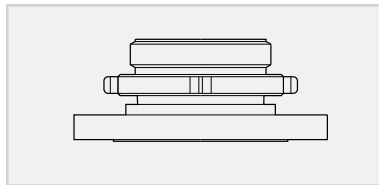

Flange X RL F SW  
FGF Part Numbers

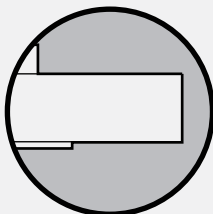
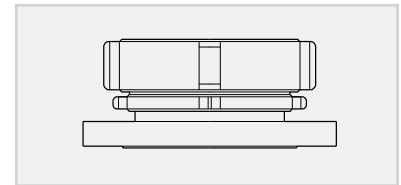

Raised Option

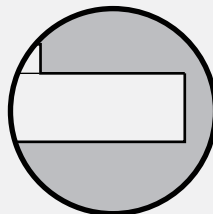





Flat Faced

Raised Option is Standard. Also available with Flat Faced ANSI Flange. Add "FF" to the part number. (For example: FGM66FF)

# SPANNERS & WRENCHES

Extensive variety of wrenches for any need





## Wrenches

				
<p><b>K01</b> Universal Spanner</p> <p>Strong, rugged, all purpose Universal Spanner has a gas cock shut-off location that provides maximum tool leverage and strength. Fits 3/4" to 6" rocker lug and pin lug fitting</p>	<p><b>K05</b> Adjustable Hydrant Wrench Double Head Spanner</p> <p>For pentagon heads up to 1 7/8" and square 1 1/2". Double hook spanner head fits 3/4" to 6" rocker lug or pin lug fittings. Replaceable jaw</p>	<p><b>K07</b> Adjustable Hydrant Wrench Single Head Spanner</p> <p>For pentagon heads up to 1 3/4" and square 1 1/4". Single hook spanner head fits 3/4" to 6" rocker lug or pin lug fittings</p>	<p><b>K08</b> Adjustable Storz Hydrant Wrench</p> <p>For pentagon heads up to 1 3/4" and square 1 1/2" -Storz spanner combination fits 4" to 6" storz; plus 3/4" to 6" rocker lug and pin lug fitting</p>	<p><b>K09</b> Adjustable Hydrant Wrench with Pinlug</p> <p>Heavy duty 1" chrome steel handle. For pentagon heads up to 1 7/8" and square heads 1 1/4" -Fits 3/4" to 6" rocker lug and pin lug fittings</p>

## Wrench Sets with Holders

	
<p><b>K45-3</b> Includes:</p> <ul style="list-style-type: none"> <li>• (1) K05 Adjustable Hydrant Wrench Double Head Spanner</li> <li>• (2) K01 Universal Spanner Wrenches</li> <li>• (1) K48 Triple Holder</li> </ul>	<p><b>K48-3</b> Includes:</p> <ul style="list-style-type: none"> <li>• (1) K07 Adjustable Hydrant Wrench Single Head Spanner</li> <li>• (2) K01 Universal Spanner Wrenches</li> <li>• (1) K48 Triple Holder</li> </ul>
	
<p><b>K49-3</b> Includes:</p> <ul style="list-style-type: none"> <li>• (1) K08 Storz Hydrant Wrench (2) K01 Hydrant Wrenches</li> <li>• (1) K48 Triple Holder</li> </ul>	<p><b>K46-2</b> Includes:</p> <ul style="list-style-type: none"> <li>• (2) K01 Universal Spanner Wrenches (1) K 46 Double Holder</li> </ul>
	
<p><b>KS34</b> Includes:</p> <ul style="list-style-type: none"> <li>• (4) KS3 Wrenches</li> <li>• (1) CAA19 Holder</li> </ul>	

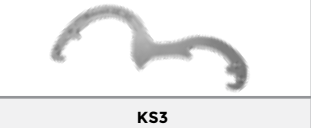
## Additional Wrenches

	
<p><b>BOST3</b> Universal Spanner</p>	<p><b>BOST2</b> Adjustable Hydrant Wrench Double Head Spanner</p>
	
<p><b>KS3</b> 4" &amp; 5" Storz x Universal Spanner Wrench</p>	<p><b>KS31</b> 6" Storz x Universal Spanner Wrench</p>

## Additional Sets

	
<p><b>K03-H</b> Hydrant Hammer</p>	<p><b>CAA19</b> Storz Spanner Wrench Holder</p>



Customize with your name

# SWC WHEEL CHOCKS

Weighing in at 4.9 lbs., the Kochek SWC Wheel Chocks are lightweight aluminum constructed stretching 8" x 7" x 10" D. Slotted openings allow hand access for quick placement and retrieval. Powder coated for corrosion resistance.

SWC-Y Safety Orange



SWC Standard Silver



Wheel Chock Storage Brackets



Optional laser-etched Fire Department Name or Logo

Partial Listing of Powder Coating colors available

Robin's Egg	Dark Blue	Lavender	Evergreen	Silver Fern	Black
Fire Engine Red	Light Burgandy	Silvadillo	Yellow/ Lime (special color)	Safety Yellow	Safety Orange
Sky White	Almond	Black Wrinkle	Lucy Brown	Bronze	



## GASKETS

Gasket Options	
	
Available in NH, NPSH & BSP	Available in Storz Pressure & Storz Suction

## LINE GAUGES

Line Gauge Options		
		
Color K-Coat	K-Coat	1.5" Gauge



## MOUNTING PLATES













Mounting Plate Options		
		
MM Male Mounting Plates	MF Female Mounting Plates	MF Storz Mounting Plates

# FORESTRY PRODUCTS

Our forestry products offer outstanding low temperature performance, excellent mechanical properties, and good resistance to oil and grease. Ranging from strainers to valves and hoses, our forestry products have you covered for every forest fire scenario.



			
<p><b>Hazmat Adapters</b></p>	<p><b>26K 2-Way Ball Valve</b> See page 33</p>	<p><b>Kochek Adapters</b> See page 38</p>	<p><b>KBH Lightweight Booster Hose</b> See page 12</p>
			
<p><b>BS151</b></p>	<p><b>Water Allocator Wand</b></p>	<p><b>Break-A-Way Nozzles</b> See page 14</p>	<p><b>SJP Thermoplastic Lined Single Jacket Forestry</b> See page 8</p>
			
<p><b>FBS15 Self Leveling Floating Strainer</b> See page 20</p>	<p><b>Hose Clamp</b></p>		



# Customer Care

**Tel: 800-420-4673**

**Email: [sales@kocek.com](mailto:sales@kocek.com)**

**75 Highland Dr. Putnam, CT 06260**

**[kocek.com](http://kocek.com)**

Customer satisfaction is our #1 priority and our recently expanded customer support team is ready to assist you.

 [Live Chat with us at Kocek.com](#)

